

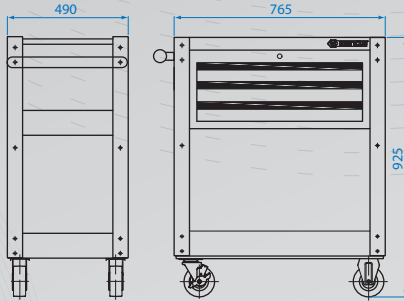



Tool Trolley

- 3 drawer trolley
- 2 PC. protective mat for top and bottom shelves
- 3 PC. protective drawer liners







- Multiple space bar to hold other tools

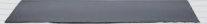

| KT NO. | Spec. | Dimension(mm) Width x Depth x Height | Casters | Static load |  | CUFT |
|-------------|--------------------------------|---|-----------|-------------|---|------|
| 87446-3B-KR | overall | 765 x 490 x 760 | 5"x1-1/4" | 600 Kg | 38 | 13 |
| | overall + 5"x1-1/4" Casters | 765 x 490 x 925 | | | | |
| 87446-3B-KB | 3 Drawer | 576 x 380 x 75 | | | | |

Accessory

| KT NO. | Contents |
|-----------|---|
| 87502-01 |  Tool holder 500mmL |
| 87502-02 |  Magnetic tool holder for workbench backpanel Size : 458 x 52 x 17mm |
| 87502-050 | U Shape hook |
| 87502-051 | 1" Shape hook |
| 87502-054 |  4" Shape hook |
| 87502-058 | 8" Shape hook |
| 87502-061 | 1" Double hook |
| 87502-064 | 4" Double hook |
| 87502-068 | 8" Double hook |
| 87502-11 |  <ul style="list-style-type: none"> ▪ Cutting board ▪ Oil-resistant, acid-resistant, moisture-resistant and anti-static ▪ 10mm PP foaming board |
| 87502-12 |  <ul style="list-style-type: none"> ▪ 4 PC. Adjusting device ▪ Includes adjustable bolt & adjustable pad |